

SKODA



The all-new  
**Epiq**

contents

**Epiq**

**Accessories**

Accessories Wheels

**Technical Data**

## Ooooooh, that's Epiq

The Epiq represents a new class of electric car for Škoda. Smaller, yet still family-friendly and supremely practical. Bold in look, smart and efficient in technology.

The Modern Solid design language also enters a new era with the Epiq. Once again, the Tech Deck Face dominates the front fascia, replacing the traditional grille and housing the sensors for the driving assists. The T-shaped LED lights both in the front and back give the Epiq an unmistakable look. The design of the 4.1-metre-long urban crossover retains the typical Škoda tornado line on the sides of the car, creating a distinct visual separation between the lower body and the glazed upper part. The result is a truly dynamic look that also emphasises the spaciousness of the car.

Inside, the Modern Solid design language translates into a new look, with simpler, sleeker lines. Traditional elements, like the two-spoke steering wheel with rollers, and a row of physical buttons, are also retained. As always, the emphasis is on practicality and smart solutions, like wireless phone charging.

The Epiq is available with 38,5 kWh and 55 kWh batteries, the larger of which provides a range of up to 441 km. Building on Škoda's latest technological advances, the Epiq also offers bidirectional charging. This allows you to power appliances or your home via the car's battery, and even includes V2G capabilities for supplying energy back to the grid.

Compact, but full of smart tricks. That's the new Epiq.





## Modern looks, solid feel

Small, but bold. The Epiq takes the Modern Solid design language to a new level. The T-shaped headlights and rear lights create an unmistakable light signature visible even from a distance. The eight vertical slats in both the front and rear bumper complete the tough, rugged look of a car that's ready to explore the world.



### Headlights

The LED running lights create an unmistakable T-shape that flanks the Tech Deck Grille. Their lower parts connect with the main headlights, which are fitted lower and also use LED technology. So you'll always see and be seen.

### Rear lights

The sleek, bold T-shape at the front is repeated at the back, making the Epiq easily noticeable even at night. The full LED technology creates a stylish look, adding a distinct touch of modern flair.



## Compact with big style

Technology is at the heart of the new Epiq. It defines the look with the new Tech Deck Face, transforming the traditional grille and adapting it to the needs of a modern car with advanced driving assistance systems. The user experience is also driven by technology. For example, you do not even need your car keys anymore, as you can use your Digital Key to unlock and start the car, with the same ease as using a traditional key.



### Charging port

With up to 105 kW of charging power, the Epiq is able to recharge from 10 to 80 percent of battery in as little as 24 minutes using DC charging at speeds of up to 105 kW. AC charging at up to 11 kW is also available, with possibility of bi-directional charging for your appliances, powering the home or supplying the grid.

### Tech Deck Face

The Tech Deck Face is a modern, glossy black interpretation of the traditional Škoda grille. With no need for a radiator grille, it now houses the car's sensors, like the front radar system and front camera. Together with the ŠKODA lettering on the bonnet, it creates an unmistakable, thoroughly modern look.



### **An Epiq place to be**

Simple elegance meets practicality. The Modern Solid design language continues inside. The sleek lines are underscored with ambient lighting, while traditional features such as the two-spoke steering wheel, physical buttons, and various Simply Clever features make for a stylish, yet practical experience. To make Epiq fit your personal taste and preferences, you can choose from four Design Selections, which include Artisyn and Technofil materials.



### Steering wheel

The two-spoke steering wheel includes two rollers for controlling the volume, scrolling menus and other functions, plus several hardware buttons for convenient operation of the most used features.

### Screens and buttons

While the 5.3" Virtual Cockpit in front of the driver provides the vital information, the 13.1" infotainment screen in the middle of the dashboard provides more in-depth information and functionality. The most frequently used features can be controlled by a row of hardware buttons below the infotainment screen.



### Always charged

Keep your phone's battery topped up at all times. The phone box in the centre console, where it's always on hand, provides up to 15 watt charging for your smartphone and cools it to prevent it from overheating.



### Apple CarPlay and Android Auto

Make use of your favourite apps safely on the go. With integrated Apple CarPlay and Android Auto, you can use selected apps through your infotainment screen. Along with the MyŠkoda App, you can use various navigation apps, stream music, and, of course, use your phone. You can even use messaging apps when the car is stationary.

### Let the world inside

Let the world inside your car. With Apple Car Play and Android Auto, you have the whole world at your fingertips via your smartphone apps. The panoramic roof makes it possible to watch the skies above – and let the sunshine inside.



### Panoramic roof

Enjoy the light, enjoy the sky. The optional panoramic roof not only offers a view of what's above, but also lets the light in. This makes the interior feel much more airy. And if the sun's too bright, simply close the electric shade.



**Rear armrest**

The rear armrest with a pair of cupholders can be folded out when the rear middle seat is unoccupied. The cupholder cover helps to stabilise drinks in case of heavy braking.



### Variable floor

More space underneath. The generous underfloor storage offers up to 24 litres of volume, conveniently hidden from prying eyes. The variable floor can be set to two different positions or removed altogether depending on how you want to divide the space.

### Luggage space

Compact on the outside, cavernous on the inside. In its standard configuration, the Epiq will surprise you with its 475 litres of luggage space.



### Folding rear seats

Need to carry something big? Simply fold the rear seats down and get 1,345 litres of volume. The 60/40 split makes it possible to fold just part of the backrest and keep one or two passenger seats.



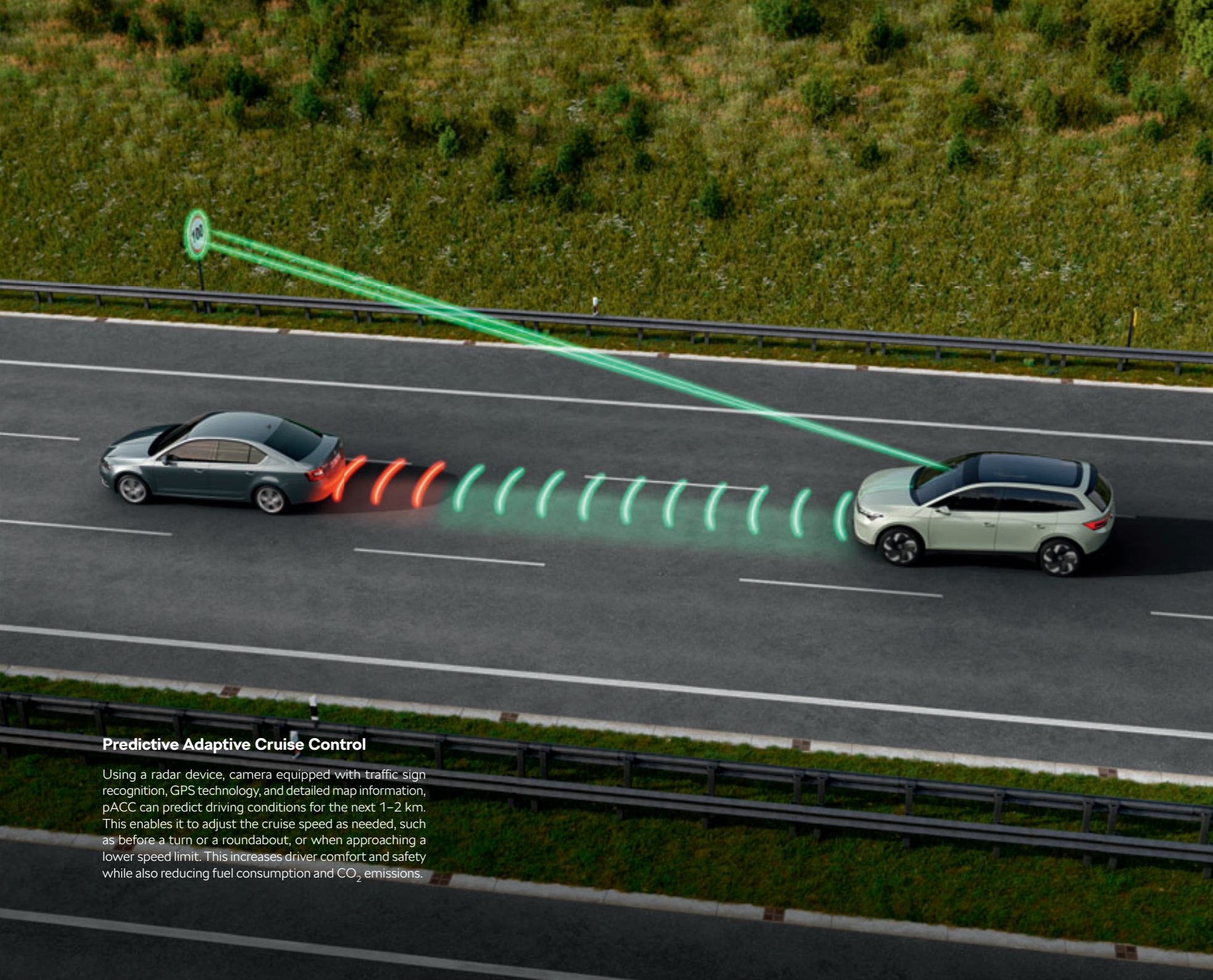

### Predictive Adaptive Cruise Control

Using a radar device, camera equipped with traffic sign recognition, GPS technology, and detailed map information, pACC can predict driving conditions for the next 1–2 km. This enables it to adjust the cruise speed as needed, such as before a turn or a roundabout, or when approaching a lower speed limit. This increases driver comfort and safety while also reducing fuel consumption and CO<sub>2</sub> emissions.

## Travel Assists

The Travel Assist system combines various useful functions and features to help you feel safe and comfortable wherever you drive. For maximum safety, the system must be constantly monitored by the driver. That's why a capacitive steering wheel detects the driver's tactility, providing an interactive interface to the system. If the driver is not engaged in driving, this behaviour is detected by the capacitive steering wheel.

### Adaptive Lane Assist

Using cameras, this system is able to keep the car in the middle of the traffic lane and alert the driver if the car leaves the optimal path. It can also take control of the car when roadworks require a lane change.

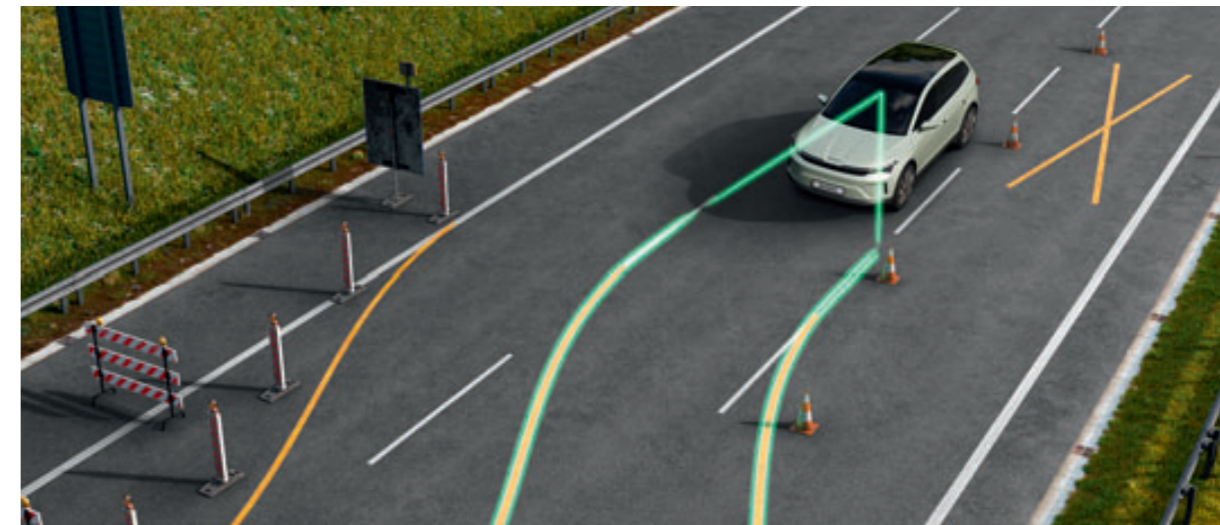

### Intelligent Park Assist

Let your car park itself. It will find and suggest a parking spot. Simply confirm, sit back, and watch as the Epiq manoeuvres itself into the parking space. You do not even have to touch the controls.



This is an illustrative image depicting an assistance system feature and does not represent any specific Škoda model.

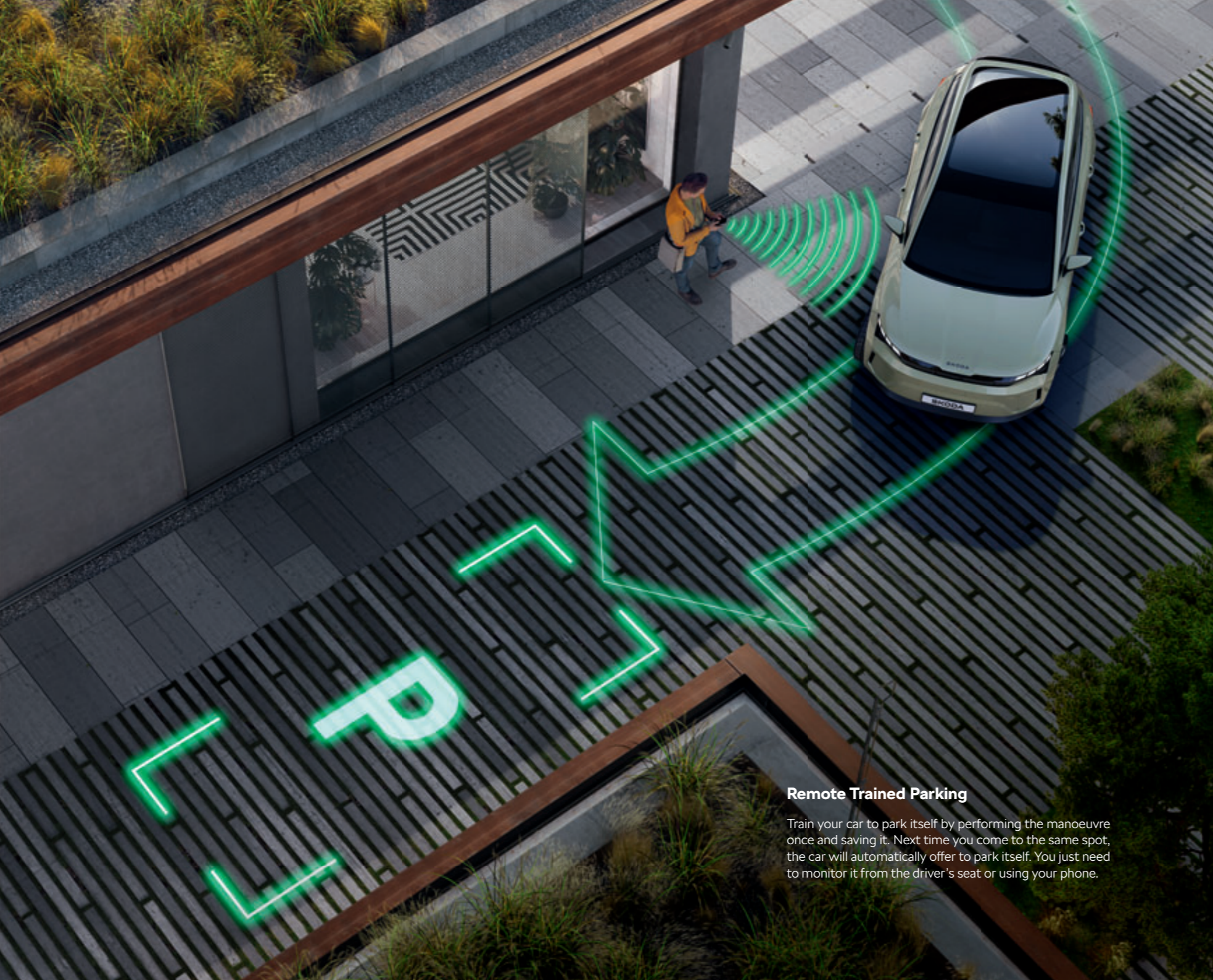

### Remote Trained Parking

Train your car to park itself by performing the manoeuvre once and saving it. Next time you come to the same spot, the car will automatically offer to park itself. You just need to monitor it from the driver's seat or using your phone.

### Trained Parking

Let the car handle your parking. First, park the car yourself and save the manoeuvre. The car will recognise the spot next time and offer to park itself. You just monitor it from the driver's seat.

### Remote Parking

Let your car park itself, while you watch from the outside. Remote Parking Assist lets you use the Intelligent Park Assist to park your car, or move it in or out of a parking space. For safety, you need to watch and control the car by keeping your finger on the button in the app.



This is an illustrative image depicting an assistance system feature and does not represent any specific Škoda model.



### Studio interior

Grained black pad  
Glossy black décor  
Black textile upholstery with grey textile inserts



### Design Selection Studio

The seat upholstery combines black textile with grey textile inserts. This is elegantly complemented by the Glossy black décor and Grained black dashboard pad.



### Loft Grey interior

Grey Techtona leather pad  
Glossy black décor  
Grey embossed textile upholstery with grey stitching



### Design Selection Loft Grey

The seat upholstery matches the Artisyne Soul leatherette with Technofil Soul material. The centre console also uses Artisyne Soul, which is also featured on the dashboard pad contrasted with Cool White stitching. The whole look is completed with Cool White décor.



### Loft Mint interior

Grey Techtona leather pad with Sage Green stitching  
Sage Green matt décor  
Mint embossed textile upholstery with Sage Green stitching



### Design Selection Loft Mint

Green dominates the Loft Mint interior. The seats are upholstered in Mint textile, combining a smooth surface on the sides and embossed squares in the middle, with Sage Green stitching to set it off. Grey Techtona leather is used on the dashboard pad, doors, and armrest, also finished with Sage Green stitching. Finally, Sage Green is also featured on the matt décor pieces.



### Suite interior

Brown Techtona leather pad with brown stitching  
Sandstorm metallic paint décor  
Embossed Suedia/Brown Techtona leather upholstery with brown stitching



### Design Selection Suite

The brown seat upholstery combines embossed Suedia in the middle with brown Techtona leather sides and brown stitching. The luxurious look is underscored by the brown Techtona leather with brown stitching on the dashboard pad and centre console. The Sandstorm metallic paint décor completes the striking look.

## Colours



Platinum White metallic



Timiano Green uni



Marble Grey uni



Pebble Silver metallic



Jasper Red metallic



Mystery Black metallic

## Wheels



19" Lark alloy wheels



18" Plover Black alloy wheels



18" Saola Silver Black alloy wheels



17" Guan steel wheel



# Accessories

## Make your Epiq feel unique

Enjoying the streets is best done in a perfectly matched outfit. Or behind the wheel of a car perfectly equipped for your needs and tastes. Customise your Epiq with Škoda Genuine Accessories and explore the world with a dash of personal style.

Boost the looks of your Epiq by choosing from a wide selection of light alloy wheels. Sizes from 18" to 20" are available, as are different designs and even colours. You can add a dash of style to the interior too, with Exclusive floor mats and metallic door sill strips.

We've also thought about your comfort and convenience. Whether smart holders for your devices, nets for your luggage in the boot or for carrying smaller items on the passenger seat, charging cables and ways to store them, or bike racks. Bring everything you need wherever you need it!

Last but not least, there's your safety and that of your passengers and even your pets. Keep your little ones safe with our comprehensive range of car seats. Seatbelts and covers for your pets keep them, you, and your car protected.

Turn your Epiq into a safe space on the road.



### Roof box\*\*

3P0 071 200 | 400 l\*  
5L6 071 175 | 380 l

### Door handle protective foil

3FA 061 193 | front, 2 pcs  
3FA 061 193A | rear, 2 pcs

### Towbar

3FA 092 155 | detachable

\* The roof box is accessible from both sides for comfortable loading and unloading of gear.  
\*\* Ask your dealer about the colour options.



#### Towbar rack

5E3 071 105 | LHD, for 2 bicycles  
000 071 105P | LHD, for 3 bicycles

#### Adapter for 4<sup>th</sup> bicycle\*

5E3 071 109 | LHD

\* This adapter is only compatible with the towbar rack for 3 bicycles.

## We Love Cycling

We love cycling, but bikes take up a lot of space. That's why we offer high-quality bicycle racks that allow you to transport up to four bicycles on your towbar or on the roof rack. Enjoy your bike ride!



#### Transverse roof rack

3FA 071 151

#### Bicycle rack

000 071 128P | aluminium



#### Charging port cover

3FA 054 410

#### V2L adapter

5LA 054 412N | for EU  
5LA 054 412P | for UK  
5LA 054 412Q | for camping

## Ready for anything

Whether charging at home or on the road, having your own charging cable comes in handy. You can also keep it pristine with a nifty cleaner. And while you're at it, give your car interior an upgrade with an elegant set of Exclusive floor mats and decorative door sill strips.



#### Foot mats

3FA 061 270 | textile Exclusive, LHD  
3FB 061 270 | textile Exclusive, RHD  
3FA 061 404 | textile Standard, LHD  
3FA 061 500 | all-weather, LHD  
3FB 061 500 | all-weather, RHD

#### Decorative door sill strips

3FA 071 303A | silver  
3FA 071 303 | black

#### Protective door sill foils

3FA 071 310 | transparent, front  
3FA 071 310A | transparent, rear



### Smart Holders

- 3V0 061 128 | adapter
- 3V0 061 127 | hanger
- 3V0 061 126 | hook
- 3V0 061 129 | multimedia holder
- 000 061 122K | Entertainment pack



### Rollout net for passenger seat

3FA 065 118 | LHD

Turn the front seat into your personal storage hub. With the new rollout net, your essentials stay right where you put them – no matter how sharp the turn or how quick the start. It's the perfect way to keep items up to 2.5 kg secure and within arm's reach.



#### Dog safety belt

000 019 409A | size S  
000 019 409B | size M  
000 019 409C | size L  
000 019 409D | size XL

#### Rear seat protection\*

3V0 061 680

\* The size of the rear seat protection can be adapted to cover just one part of the rear seats.

## Comfortably safe

They can't drive, but they can still enjoy the epic ride in the back! Your little ones will be safe and comfortable in our range of child seats from 0 to 36 kilograms, including a new universal seat for children up to 19 kg. Have a four-legged friend? Give them their own private lounge with comfort and protection in mind – both for them and your upholstery!



#### DUALFIX PRO child seat

(0–4 years, 76–105 cm, 0–19 kg, 4-point seat belt)

50A 019 906

#### Protective pad under child seat

000 019 819A



**Charging cable bag**

5LA 087 317B

## A bootful of ideas

Having everything neatly organised is not only practical, it's also safer. Keep everything in its place, so you can easily find what you need and stop things flying around while you drive. Enjoy having your charging cables always on hand, even when your boot is full, as well as convenient access to a cold drink or snack.



**Autocooler 14 l**

6VA 065 400

**Universal fixing elements**

6V0 061 104



**Net programme**

3FA 065 110 | black



**Double-sided boot mat – crate**

3FA 061 163A

Elegance for daily use or ruggedness for your adventures? This versatile mat features a soft, stylish textile side for your everyday luggage and a durable, easy-to-clean rubber side for wet or dirty items. Plus, its smart design allows you to fold it into a practical box-shaped crate, keeping your belongings perfectly organised and secure on the go.



**Boot dish**

3FA 061 162

**Universal fixing elements**

6V0 061 104



**Double-sided boot mat with hinge**

3FA 061 163

## Accessories Wheels

20"



**Macaw**

black metallic, brushed, smokey top coat  
8.0J × 20" ET40 for 225/40 R20  
3FA 071 490 DTQ

19"



**Nivalis**

black metallic, brushed, smokey top coat  
8.0J × 19" ET40 for 225/45 R19  
3FA 071 499 DTQ



**Nivalis**

black metallic, brushed  
8.0J × 19" ET40 for 225/45 R19  
3FA 071 499A FL8

18"



**Pyxis**

black metallic, brushed  
7.0J × 18" ET41 for 225/50 R18  
3FA 071 498C FL8



**Pyxis**

anthracite metallic, brushed  
7.0J × 18" ET41 for 225/50 R18  
3FA 071 498D HA7



**Pyxis**

silver metallic, brushed  
7.0J × 18" ET41 for 225/50 R18  
3FA 071 498B 8Z8

18"



**Atik**

black metallic  
7.0J × 18" ET41 for 215/50 R18\*, 225/50 R18  
3FA 071 498A FL8



**Atik**

silver metallic  
7.0J × 18" ET41 for 215/50 R18\*, 225/50 R18  
3FA 071 498 8Z8

# Technical Data

Technical specifications	55
--------------------------	----

Engine	
Power (kW)	155
Torque (Nm)	290
Battery capacity (kWh) – gross	55
Battery capacity (kWh) – net	51.7

Performance	
Maximum speed (km/h)	160
Acceleration 0–100 km/h (s)	7.1
Range – WLTP (km)	429–441
Energy consumption WLTP (kWh/100 km) – combined	13,7–14,1

Drive type	
Drive	Front-wheel drive

Charging	
AC (0–100%) – power/time (according to the type of cable)	11 kW/5.5 h
DC (10–80%) – power/time	105 kW/24 min

Weight	
Kerb weight – in standard version without driver (kg)	1,543–1,637
Payload – incl. driver and extra equipment (kg)	443–537

Further specifications			
Body		Front brakes	Internally cooled disc brakes
Type	5-seater, 5-door, 2-compartment	Rear brakes	Disc brakes
Chassis		Clearance (mm)	157
Front axle	MacPherson suspension with a sheet metal subframe and lower wishbones	Luggage storage space (max. l)	475
Rear axle	Twist-beam axle, with five transverse arms, without a longitudinal arm	Without spare tyre, with rear seat backrests – upright/down	585/1,345

The maximum power is determined in accordance with UN-GTR.21. The maximum power is available when the high-voltage battery is at its highest possible state of charge (SoC) and operating within its optimal temperature range. The power available varies according to the driving scenario and is influenced by factors including the battery's temperature, its SoC, and the physical ageing of the high-voltage battery.

WLTP – World harmonized light-duty vehicles test procedure.

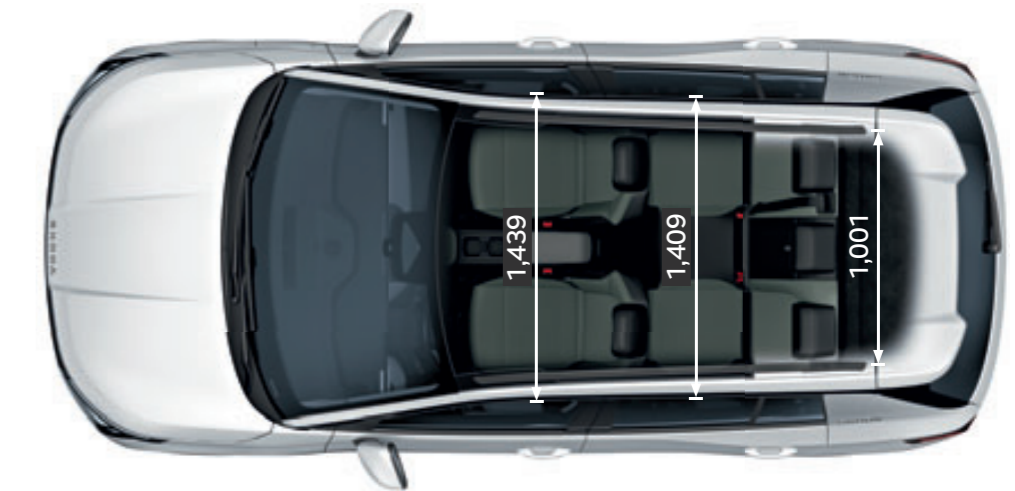
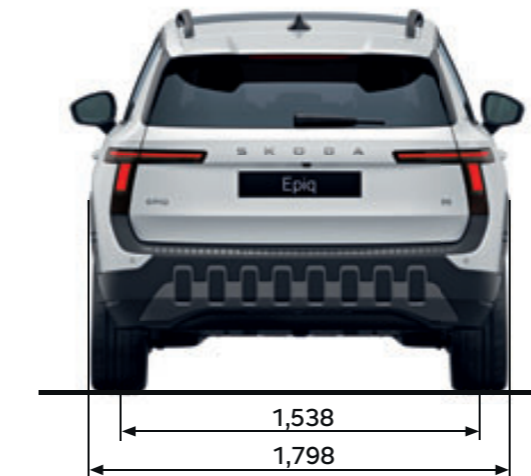
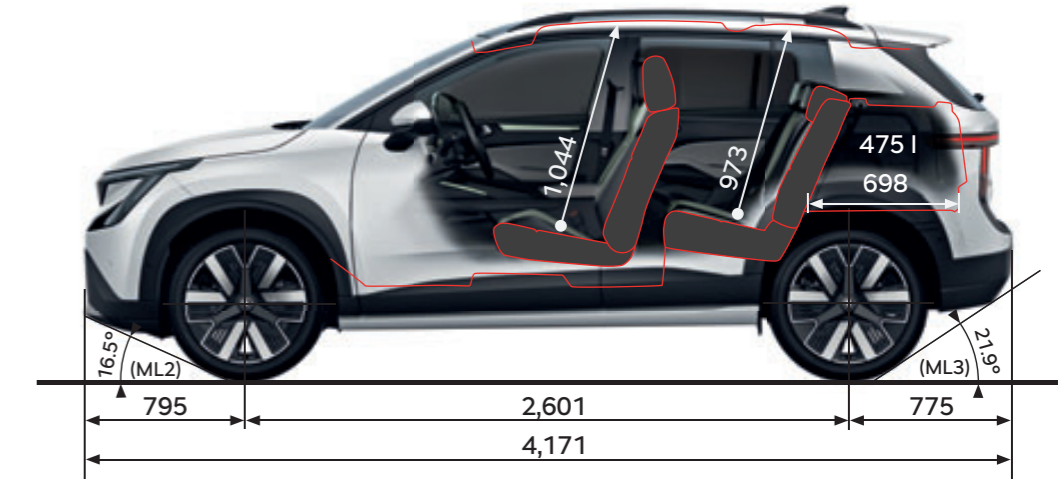
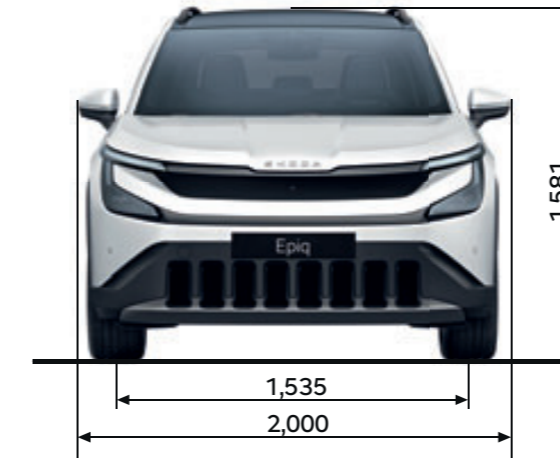

Specifications may differ depending on the battery version and chassis configuration.

### Disclaimer

The specified values refer to the achievable charging power of a new vehicle. This may decrease with the ageing of the battery. The ageing of the battery depends on a number of factors, including the load, charge cycles, and the charging management used.

The images presented in this catalogue (brochure) are used for illustrative purposes only and are not intended to form part of any contract or warranty. They display pre-series cars and certain illustrations, features, parts, and equipment may differ from the actual production cars and from country to country. To get the exact specification of features, parts, and equipment, please get in touch with your nearest local Škoda dealer.

If you've enjoyed reading  
about it – imagine driving it.  
**Call us to arrange  
a test drive!**

05/2026

Your Škoda partner:



### MyŠkoda

Enjoy full control of your car. Download MyŠkoda and access all necessary services anytime, whether it's driving data, fuel range, lock and unlock, or even where you last parked.



### Assembly manuals

Follow the user manuals to install Škoda Genuine Accessories on your car correctly. You can also visit your authorised Škoda Service partner.