

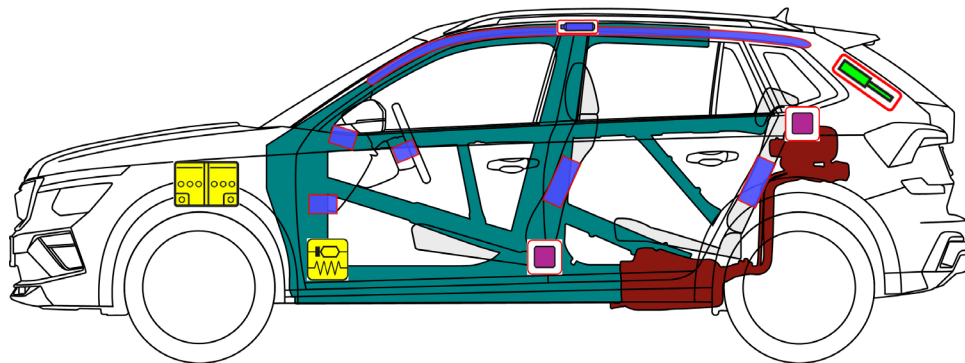

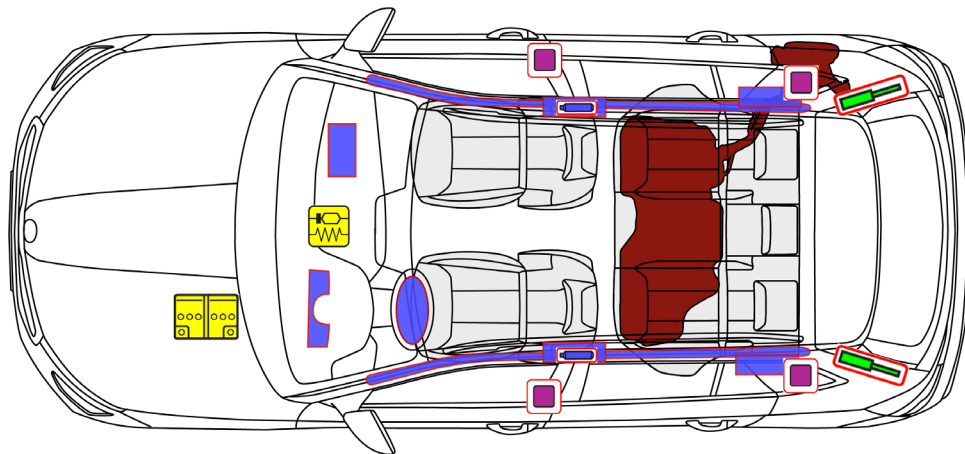







# Škoda Kamiq

5 doors/5 seats/hatchback  
from 2024



	Airbag		Stored gas inflator		Seat belt pretensioner		SRS control unit		Fuel tank
	Gas strut/preloaded spring		High strength zone		Battery low voltage				



# Škoda Kamiq

5 doors/5 seats/hatchback  
from 2024

## 1. Identification / recognition

Lettering



## 2. Immobilisation / stabilisation / lifting

Immobilising the vehicle



1. Switch to position "P"
2. Apply the parking brake
3. Switch off the ignition (power display "OFF")
4. Secure the vehicle so it cannot roll away

Lifting points

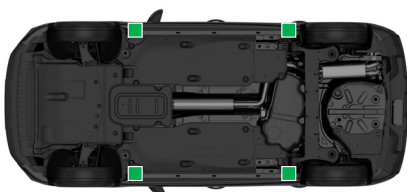

 Suitable lifting points

## 3. Disable direct hazards / safety regulations

Switching off the ignition



- Turn the ignition key and remove it or
- Press the "Engine Start/Stop" button in the steering column without engaging the brake pedal.

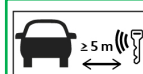

Keep the vehicle key at least five metres away from the vehicle wherever possible.



Disconnecting the 12-volt battery



In the engine compartment  
Disconnect the negative terminal from the battery

## 4. Access to the occupants

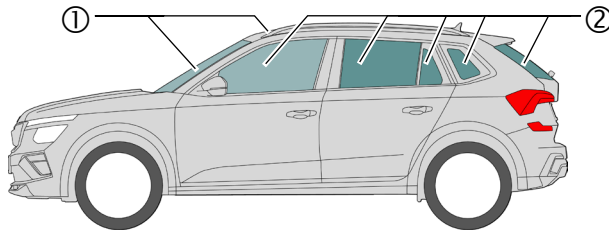

### Glass types:

- ① Composite safety glass
- ② Single-pane safety glass

Electrical seat adjustment



Mechanical seat adjustment



Mechanical steering column adjustment



## 5. Stored energy / liquids / gases / solids



Gasoline, max. 50 l



12 V

## 6. In case of fire

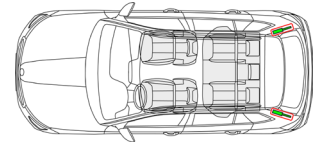

## 7. In case of submersion

Once the vehicle has been recovered, let the water drain out and disconnect the battery or batteries (see chapter 3). Use appropriate personal protective equipment!



# Škoda Kamiq

5 doors/5 seats/hatchback  
from 2024

## 8. Towing / transportation / storage

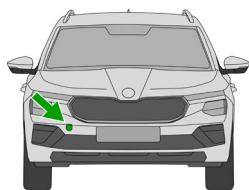

Front towing eye on the right-hand side of the vehicle

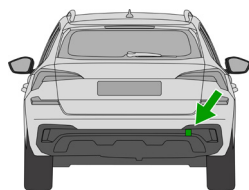

Rear towing eye on the right-hand side of the vehicle



If a vehicle has been involved in an accident, do not tow it on its drive axles.

## 9. Important additional information

Škoda Emergency Services Rescue Sheets: [www.skoda-auto.com/services/rescuers](http://www.skoda-auto.com/services/rescuers)

## 10. Explanation of pictograms used

Flammable	Corrosives	Hazardous to the human health	Environmental hazard	Vehicle on fuel of liquid group 2	Use water to extinguish the fire	Remove smart key	Release the bonnet